



SUMMER– 18 EXAMINATION

Subject Name: CONSTRUCTION MATERIALS

Model Answer

Subject Code:

22204

**Important Instructions to examiners:**

- 1) The answers should be examined by key words and not as word-to-word as given in the model answer scheme.
- 2) The model answer and the answer written by candidate may vary but the examiner may try to assess the understanding level of the candidate.
- 3) The language errors such as grammatical, spelling errors should not be given more Importance (Not applicable for subject English and Communication Skills).
- 4) While assessing figures, examiner may give credit for principal components indicated in the figure. The figures drawn by candidate and model answer may vary. The examiner may give credit for any equivalent figure drawn.
- 5) Credits may be given step wise for numerical problems. In some cases, the assumed constant values may vary and there may be some difference in the candidate's answers and model answer.
- 6) In case of some questions credit may be given by judgement on part of examiner of relevant answer based on candidate's understanding.
- 7) For programming language papers, credit may be given to any other program based on equivalent concept.

Q. No.	Sub Q. N.	Answers	Marking Scheme
Q.1	(a) Ans	<b>Attempt any FIVE of the following:</b> <b>List any four artificial construction materials.</b> Artificial construction materials. <ol style="list-style-type: none"><li>1. Cement.</li><li>2. Brick.</li><li>3. Concrete.</li><li>4. Mortar.</li><li>5. Tiles.</li><li>6. Glass</li></ol>	Any four 1/2 M each
Q.1	(b) Ans	<b>State the factors on which the selection of type of materials depend.</b> Factors for selection of materials. <ol style="list-style-type: none"><li>1. <b>Carry prescribed loads:</b> The most significant requirement of a material used in civil engineering project is that it should be able to carry the design loads. In other words, the material should have adequate strength.</li><li>2. <b>Durability:</b> Selection of material should be such that it should sustain designed load for design duration or period. It should resist the weathering action caused by wind, rain, snow etc.</li><li>3. <b>Economical:</b> In most of the cases, the cost of raw material account about the finished cost. Obviously the cost of the material is a major factor which influences the choice of the material or process.</li><li>4. <b>Environmental friendly:</b> A construction material should satisfy all strength, serviceability, and architectural requirement and at the same time, must not cause environmental problem.</li><li>5. <b>Aesthetically pleasing:</b> Most nonstructural materials such as floor coverings, paints, and doors and window are chosen based on aesthetic consideration.</li></ol>	Any four 1/2 M each
Q.1	(c)	<b>List the four tools required for dressing of stone.</b>	



	Ans	Tools required for dressing of stone. 1. Spall hammer 2. Dummy 3. Gad 4. Scrabbling hammer 5. Mallet 6. Drag 7. Pitching tool 8. Boaster 9. Point <b>10.</b> Punch	Any four 1/2 M each
Q.1	(d) Ans	<b>List major ingredients of cement.</b> Major ingredients of cement. 1. Lime (CaO) 2. Silica (SiO <sub>2</sub> ) 3. Alumina (Al <sub>2</sub> O <sub>3</sub> ) 4. Iron oxide (Fe <sub>2</sub> O <sub>3</sub> ) 5. Magnesia (MgO) <b>6.</b> Gypsum (CaSO <sub>4</sub> . 2H <sub>2</sub> O)	Any four 1/2 M each
Q.1	(e) Ans	<b>State any two uses of precast concrete blocks.</b> Uses of precast concrete block. 1. In parking areas, footpaths, on road to give pleasant look. 2. Fencing poles for fencing work. 3. It is used for loadbearing masonry, in earthquake zones. <b>4.</b> Lightweight blocks for partition walls.	Any two 01 M each
Q.1	(f) Ans	<b>State any two uses of "Plaster of Paris".</b> Uses of Plaster of Paris. 1. It is used as architectural decoration material for false ceiling, cornices and other decorative feature in interior finish. 2. It is used for making casts for statues. 3. It is used for wall plasters, wall board etc. 4. Ornamental work.	Any two 01 M each
Q.1	(g) Ans	<b>Give any two uses of granite and marble polishing waste.</b> Use of granite and marble polishing waste. 1. It is used in manufacturing of brick and tiles 2. It is used for filling joints in flooring. <b>3.</b> It is used in self-compacting concrete.	Any two 01 M each
Q.2	(a) Ans	<b>Attempt any THREE of the following:</b> <b>Describe the factors for selection of construction materials on the basis of strength.</b> Material must be selected for their ability to support the loads imposed by the building over the whole life of the building. An appropriate structural system and correct selection of structural materials can reduce excess material use and waste and increase the building adaptability for other uses. Material should be used as per their functional requirement. A highly durable material may provide the most sustainable solution, if it reduces maintenance or replacement requirement, but the material should also be appropriate for expected life of the building.	02 M  02 M
Q.2	(b)	<b>State the role of civil engineer in the field of transportation engineering.</b>	



	Ans	<p>Role of civil engineer in the field of transportation engineering.</p> <ol style="list-style-type: none"><li>1. To maintain safety, adequacy and economy in the means of transport for the need of society.</li><li>2. Civil engineer work to move people, goods and materials safely and efficiently from one place to another place.</li><li>3. Civil engineer designs, constructs and maintains all types of transportation facilities, including airport, highway. Railway track and docks and harbors.</li><li>4. Civil engineers are also involved in the construction of bridge tunnels etc.</li><li>5. Remote areas and rural areas become accessible and communicable if connected by proper means of transport.</li></ol>	Any four 01 M each
Q.2	(c) Ans	<p><b>Describe the selection criteria for selecting stone for face work of building.</b></p> <p>Selection criteria for selecting stone for face work of building.</p> <ol style="list-style-type: none"><li>1. <b>Appearance:</b> For face work it should have fine, compact texture; Light-coloured stone is preferred as dark colours are likely to fade out in due course of time.</li><li>2. <b>Structure:</b> A broken stone should not be dull in appearance and should have uniform texture free from cavities, cracks, and patches of loose or soft material. Stratifications should not be visible to naked eye.</li><li>3. <b>Strength:</b> A stone should be strong and durable to withstand the disintegrating action of weather. Compressive strength of building stones in practice range between 60 to 200 N/mm<sup>2</sup>.</li><li>4. <b>Weight:</b> It is an indication of the porosity and density. For stability of structures such as dams, retaining walls, etc. heavier stones are required, whereas for arches, vaults, domes, etc. light stones may be the choice.</li><li>5. <b>Hardness:</b> This property is important for floors, pavements, aprons of bridges, etc. The hardness is determined by the Mohr's scale.</li><li>6. <b>Toughness:</b> The measure of impact that a stone can withstand is defined as toughness. The stone used should be tough when subjected to vibratory or moving loads.</li></ol>	Any four 01 M each
Q.2	(d) Ans	<p><b>Explain defects in timber with neat sketch.</b></p> <p>Types of Defects in timber are grouped into the following divisions. The main natural forces responsible for causing defects in timber are abnormal growth and rupture of tissues.</p> <ol style="list-style-type: none"><li>1. <b>Knots:</b> Bases of branches or limbs which are broken or cut off from the tree as shown in the figure.</li></ol> <div data-bbox="544 1491 1104 1701" data-label="Image"></div> <ol style="list-style-type: none"><li>2. <b>Star Shake:</b> These are radial splits or cracks widest at the circumference and get diminishing towards the center of the tress. These may arise mostly from severe frost and fierce heat of sun.</li></ol>	

Any four  
01 M each

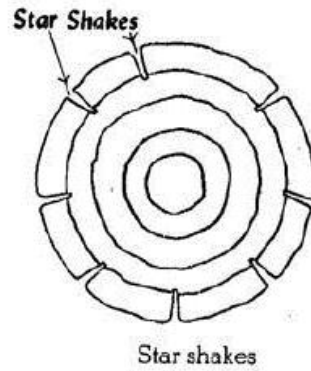

3. **Heart Shakes:** These are the splits or cracks widest at the center and diminishing towards the outside circumference, this defects usually occurs in over matured trees and is probably caused due to the shrinkage of heart wood

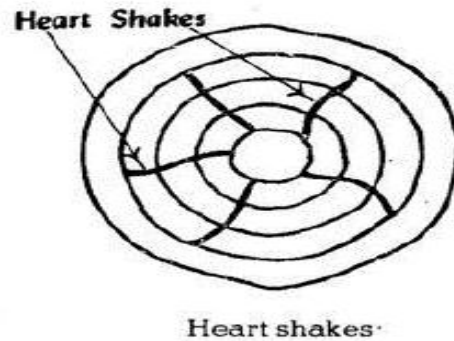

4. **Twisted fibers:** caused by twisting of young trees by fast blowing wind as shown in figure.

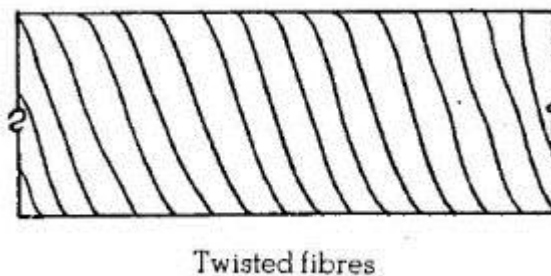

5. **Radial Shake:** These are similar to star shakes but they are fine, irregular and numerous. They usually occur when tree is exposed to sun for seasoning after being felled down.

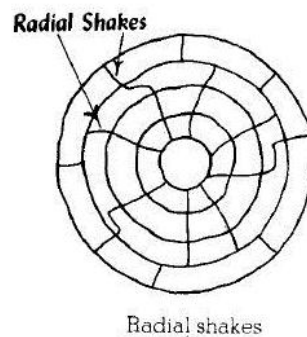

6. **Rind galls:** Rind means bark and gall indicates abnormal growth and peculiar curved swellings found on the body of a tree.

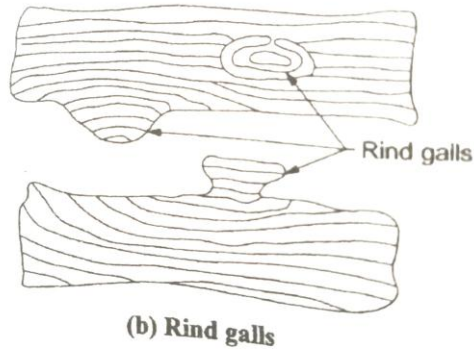

Q.3

(a)

**Attempt any. THREE of the following:**

**Draw neat sketches of:**

**(i) Conventional bricks and**

**(ii) Standard bricks showing all the dimensions**

Ans

i) Conventional brick.

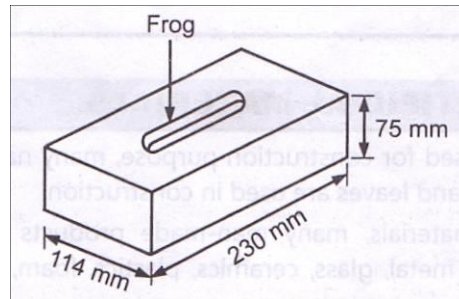

ii) Standard brick.

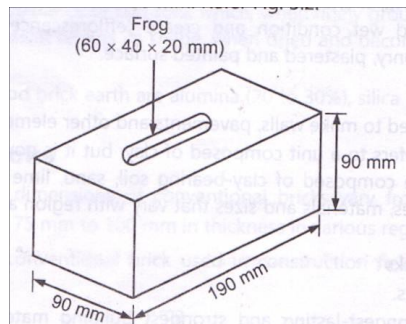

02 M

02 M

Q.3

(b)

Ans

**State any four situations where hollow concrete block masonry is used.**

Situations where hollow concrete block masonry is used.

- 1) Hollow concrete blocks are fire resistant and hence are used in masonry where fire resistance is necessary, like furnace, chimney etc.
- 2) Hollow concrete blocks are light weight. , and hence used in partition walls to reduce dead load of wall.
- 3) Hollow concrete blocks are having good insulating properties and used in exterior load bearing masonry walls where sound and thermal insulation is essential. It keeps house cool in summer and warm in winter.
- 4) Hollow concrete blocks are used in compound walls where economic construction is necessary.
- 5) They are used to achieve uniform quality of masonry, faster construction.

Any four  
01 M for  
each

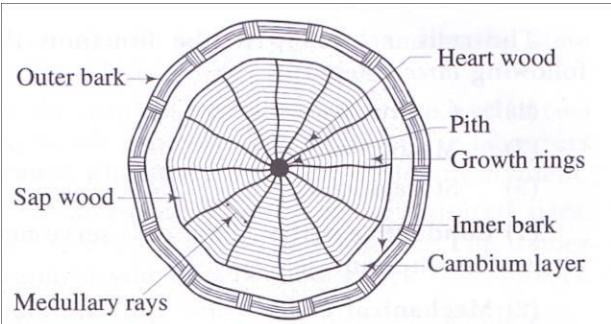

		6) They are used to achieve lower labor involvement and greater durability, like Retaining walls.	
Q.3	(c) Ans	<b>Write the field tests performed on bricks for its suitability.</b> Field tests performed on bricks for its suitability: 1) Shape and size: Brick is closely observed. It should be of standard size 190mm x 90mm x 90mm. Its shape should be truly rectangular with plane faces, sharp edges and right angles. 2) Water absorption test: A brick is weighed dry. It is then immersed in water for a period of 16 hours. It is weighed again and difference in weight indicates the amount of water absorbed by the brick. It should not be more than 20% of weight of dry brick. 3) Hardness: A scratch is made on brick surface with a finger nail. If no impression is left on the surface then brick is treated sufficiently hard. 4) Soundness: Two bricks are taken and they are struck with each other. Brick should not break and clear ringing sound should be produced. 5) Color Test: Brick should have copper colored and free from cracks, holes, and lumps. 6) Structure: A brick is broken and structure inside should be uniform, compact, and homogeneous. 7) Presence of soluble salts: Brick is immersed in water for 24 hours. It is then taken out and allowed to dry in shade. The absence of white deposits on its surface indicates absence of soluble salt.	Any four 01 M for each
Q.3	(d) Ans	<b>State suitability of:</b> <b>(i) Water proofing materials and (ii) Sound insulating materials</b> i) <b>Suitability of water proofing materials:</b> 1. Concrete, Bricks, Stones, plaster have tendency to get deteriorate, hence leakage of water may occur in slab, beam, columns. Bitumen and tars are used for water proof coatings for making surfaces hydrophobic, for priming surfaces. 2. Fibre glass water proofing material is a roll water proofing material suitable for roofs and slabs. 3. Sealing water proof material are used for filling exterior joints in buildings and installations 4. Prefabricated water proofing concrete items are suitable for anti-corrosion waterproofing of installations 5. Water proofing asphalt slabs are suitable for the waterproofing work and filling of deformation joints. 6. Paints are suitable for the waterproofing of external walls where cracks are developed. 7. Plastics waterproofing membranes in the form of sheets prevent water penetration into pores and voids in structures. 8. Water proofing chemicals in liquid or powder form like zinc sulphate, alkaline silicates calcium chloride are added to concrete to improve resistance to water absorption. 9. Water repellents like soda, potash, calcium soaps, and waxes are suitable for pore blocking. ii) <b>Suitability of sound insulating materials:</b> 1) In Porous materials with a solid skeleton, sound is absorbed as a result of viscous friction inside the pours. Light weight concrete with porous aggregate, foam glass, mineral wool, glass wool in the form of strips, slabs, roll, mats are suitable	Any four 1/2 M for each

		<p>materials used in various constructions underneath the floor.</p> <ol style="list-style-type: none"> <li>2) Porous jagged structures, based on plastics, rubber are available in the form of strips and liners. They provide sound proofing of reinforced concrete floors.</li> <li>3) Loose composition, like artificial and natural sand, slag is used as fillers.</li> <li>4) Panel material like veneer panel, rigid wood fibre board, are suitable for interior finishing of buildings to improve acoustic properties by dampening noises.</li> <li>5) Baffle materials which includes, thin panels from veneer, solid card board are suitable for facing suspended ceilings to insulate noise.</li> <li>6) Acoustic tiles and acoustic plaster are suitable where absorption of sound is required.</li> </ol>	Any four 1/2 M for each
Q.4	(a) Ans	<p><b>Attempt any THREE of the following:</b> <b>Draw a neat sketch of cross-section of an exogenous tree and label the parts.</b> Cross-section of an exogenous tree:</p> 	02 M for sketch 02 M for labeling
Q.4	(b) Ans	<p><b>Write any four uses of plywood.</b> Uses of plywood:</p> <ol style="list-style-type: none"> <li>i) Plywood is used for preparing door panels and shutters of cup boards.</li> <li>ii) It is used for false ceilings for interior designing .</li> <li>iii) For making chairs, tables ,and other kitchen furniture, office cabins</li> <li>iv) For making partitions between two rooms.</li> <li>v) For paneling of walls</li> <li>vi) For railway coaches</li> <li>vii) For formwork for concrete.</li> <li>viii) For packing cases.</li> </ol>	Any four 01 M for each
Q.4	(c) Ans	<p><b>State situations where sound insulating and damp proofing materials are used.</b> <b>Situations where sound insulating materials are used:</b></p> <ol style="list-style-type: none"> <li>1) Glass, mineral wool mats, are used as sound insulators as solid inner layers underneath floors,</li> <li>2) Wood fibre and asbestos cement slabs are used as strip lining in floors.</li> <li>3) Plastic slabs are used for sound proofing of RCC floors.</li> <li>4) Wood fibre board is used as sub floors to insulate impact noise.</li> <li>5) Mineral wood boards are used in special chambers.</li> <li>6) Gypsum plaster boards are used for facing walls and ceilings</li> <li>7) Perforated plywood is usually suspended from trusses, so as to provide air space.</li> <li>8) Asbestos cement acoustic baffles are used for facing suspended ceilings or walls to insulate noise.</li> <li>9) Acoustical tiles are used where uniform sound absorption is necessary.</li> <li>10) Acoustic plaster made by mixing cement and granular insulating material is used on walls to make wall and room sound proof.</li> </ol> <p><b>Situations where Damp proofing materials are used:</b></p>	Any four 1/2 M for each

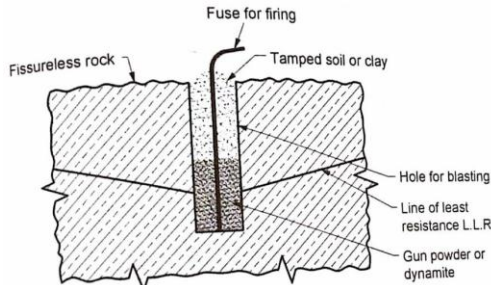
		<p>1) Damp proof course of Concrete with damp proofing chemicals is used over masonry at foundation and plinth to prevent dampness.</p> <p>2) Damp proof course of concrete with chemicals is used below flooring of marble, granite.</p> <p>3) Damp proofing materials are used on external side of walls to prevent dampness.</p> <p>4) Damp proofing materials are used in toilet floors of upper story, so that no dampness will occur in slab below that floor.</p>	Any four 1/2 M for each
Q.4	(d) Ans	<p><b>State the applications of geo-polymer cement.</b></p> <p>Application of geo polymer cement:</p> <p>1) It is used in geo-polymer concrete, as a substitute for ordinary Portland cement.</p> <p>2) It is used in transportation like roads, Bridges, embankment etc.</p> <p>3) It is used in construction of building components.</p> <p>4) It is used in manufacturing of pavement blocks.</p> <p>5) Geo-polymer cement has off shore application also.</p>	Any four 01 M for each
Q.4	(e) Ans	<p><b>State the situations where following paints are used:</b></p> <p><b>(i) Oil paints</b></p> <p><b>(ii) Distempers</b></p> <p><b>(iii) Varnishes</b></p> <p><b>(iv) Cement paints</b></p> <p>Situations where following paints are used:</p> <p><b>1) Oil paints:</b> structural steel members to protect from corrosion, wooden doors and windows, walls, ceilings, to protect from insects.</p> <p><b>2) Distempers :</b> on internal walls , ceilings</p> <p><b>3) Varnishes:</b> wooden surface of doors and windows, Brightening coats of painted surfaces, To improve appearance of ornamental grains of wood surfaces.</p> <p><b>4) Cement paint:</b> on external walls of building, stone masonry, concrete surfaces</p>	01 M for each
Q.5	(a) Ans	<p><b>Attempt any THREE of the following:</b></p> <p><b>Describe four steps in operation of stone blasting.</b></p> <p>The stone blasting process is carried out by adopting following operations.</p> <p>1) <b>Drilling holes in the stones:</b> Holes are drilled upto the required depth of the line of least resistance manually by means of a knife-edged steel bar called as jumper or by rotary drilling machine.</p> <p>2) <b>Charging the hole :</b> After drilling; the holes are cleaned properly and allowed to dry. Then gun powder or dynamite or blasting gelatin or any other suitable explosive is inserted into the drilled hole along with fuse as shown in fig.</p> <div style="text-align: center;">  </div> <p>3) <b>Tamping:</b> After charging the hole by the explosive powder, the remaining portion of hole is filled with clay or ash and compacted with the help of tamping bar. Care is to be taken at the time of tamping, the one end of the fuse should be at the bottom of hole completed merged in explosive powder and other end should be out from the</p>	01 M for each step



hole so that it becomes easy for firing.

**4) Firing:** For the purpose of firing, a fuse is inserted throughout the hole. The free end of fuse is finally fired either with a match or electricity. Detonators are being used for firing if dynamite is used as explosive. After blasting, disintegrated blocks of stones are collected and transported to the required site under construction.

Q.5  
(b)  
Ans.

**Explain with neat sketch patterns provided in the dressing of trap stone.**

Following Patterns are provided in the dressing of stones

- 1. Hammer Dressing:** In this case, stone blocks are roughly made rectangular by means of wallers hammer. The exposed face is roughly shaped by a mash hammer.



- 2. Pitched face dressing:** In this case the edges of stone upto 25 mm on all side are dressed in level and superfluous stone on the face is remained as it is on the face

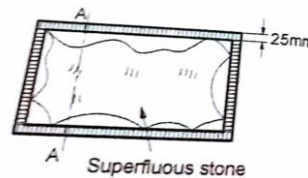

- 3. Chisel drafting:** In this type of dressing, drafts are made at all four edges with the help of chisel and any superfluous stone at all centre is removed by pitching tool or scrabbling hammer. This type of dressed stones is used in the masonry work as a quoin stones at corner.

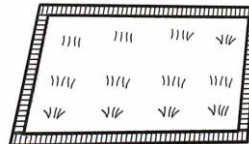

- 4. Roughed tooled dressing:** In this type of dressing work; first edges are made squared and then a series of continuous and parallel fine chisel lines are developed on the face with the help of batting or broad tool. This is common dressing for ashlar masonry work.

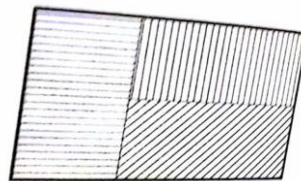

- 5. Punched dressing:** In this case, a rough tooled surface is further dressed so as to form the series of parallel ridges with the help of punch.

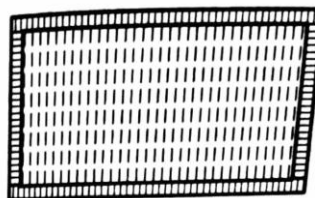

- 6. Reticulated finish:** In this type of dressing, polygonal or irregular shaped

Any four  
01 M for  
each



reticules are formed in the central portion of the stone.

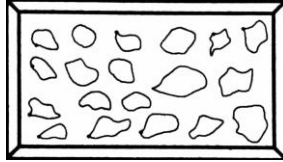

7. **Vermiculated finish:** In this finish, the sinking about 10 mm below surface is made more curved which resembles like worm eaten appearance.

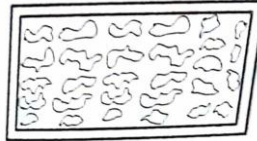

8. **Picked finish:** In this type of finish, the exposed face of the stone is dressed with the help of a tool called as point and thus it forms small pits on the exposed surface. In this finish, most of the projections are removed and it gives fine surface to the stone face.



Q.5

(c)

**Suggest the type of cement used for the following :**  
**(i) For modular construction where form work needs to be removed early for re-use. .**  
**(ii) Mass concreting such as construction of dam.**  
**(iii) Decorative works in external surfaces of building.**  
**(iv) Cementing the oil well.**

Ans.

- i) For modular construction where form work needs to be removed early for re-use. – Rapid Hardening Cement  
ii) Mass concreting such as construction of dam. – Low heat cement.  
iii) Decorative works in external surfaces of building – Coloured cement.  
**iv) Cementing the oil well. – Oil Well Cement.**

01 M for each

Q.5

(d)

**Classify burnt clay bricks.**

Ans.

The bricks used in the construction works are burnt bricks and they are classified into the following four categories:

- 1) First class bricks
- 2) Second class bricks
- 3) Third class bricks
- 4) Fourth class bricks.

**First Class bricks:** These bricks are table moulded and of standard shape and they are burnt in kilns. The surfaces and edges of the bricks are sharp, square, smooth and straight. These bricks have all qualities of good bricks. These bricks are used for superior work of permanent nature.

**Second class bricks:** These bricks are ground – moulded and they are burnt in kilns. The surface of these bricks is somewhat rough and shape is also slightly irregular. These bricks may have hair cracks and their edges may not be sharp and uniform. These bricks are commonly used at places where brickwork is to be provided with a coat of plaster.

**Third Class bricks:** These bricks are ground – moulded and they are burnt in clamps. These bricks are not hard and they have rough surfaces with irregular and distorted

01 M for each





		<p>3) Injection mortar 4) Acoustic mortar, and 5) X-ray projection mortar Uses of special mortars-</p> <p>1) <b>Hydraulic Mortar</b> – For plastering surfaces of various vessels for liquid products, walls of surfaces of basements, which are made with Portland cement, sulphate resistant Portland cement and waterproofing expanded cement.</p> <p>2) <b>Insulating Mortar</b> – To increase the thermal insulation, various compacting admixtures such as sodium aluminate, emulsified asphalt and latexes are added to the mixture.</p> <p>3) <b>Injection Mortar</b> – For filling grout are intended to fill channels in pre-stressed constructions for protection of reinforcement against corrosion.</p> <p>4) <b>Acoustic Mortar</b> – Used for making sound proofing plasters.</p> <p>5) <b>X- Ray protection Mortar</b> – Used for plastering the walls and ceiling of X-ray rooms.</p>	Any four 01 M for each
Q.6	(c) Ans.	<p><b>Write any four uses of rice husk</b></p> <p><b>Uses –</b></p> <p>1) In the manufacturing of bricks. 2) In thermal insulation of building, rice husk can be used. 3) The ash produced after the husks have been burned is high in silica, which is used in production of aggregates and fillers for concrete and board. 4) Used in generation of heat energy, steam energy and electricity generation.</p>	01 M for each
Q.6	(d) Ans.	<p><b>Write the situations where Geo-synthetic material products and artificial timber is used.</b></p> <p><b>Geosynthetic material products are used in following situations-</b></p> <p>1) When there is a possibility of piping i.e. soil movement due to movement of water. To prevent soil movement (piping), while letting water move through the material. 2) When it is necessary to improve grade soil situations such as roads valleys or laneways etc. 3) When it is necessary to improve sloped grade situations such as banks or hill sides. 4) When the soil is weak and it is necessary to improve the strength of soil i.e. reinforcing soil for soil walls, bridge abutments, box culverts, bridges and soil arches. 5) Whenever it is necessary to control water pressure i.e. allowing the flow in the plane of material such as foundation walls.</p> <p><b>Artificial timber is used in the following situations-</b></p> <p>1) When it is necessary to use wood with any substitute material 2) When it is necessary to improve the properties of goods, product, or furniture like termite resistance, resistance against hot water and chemicals, hardness with comparison to natural wood. 3) When it is necessary to improve the appearance with the use of artificial timber for flooring.</p>	Any two 01 M for each  Any two 01 M for each